

**TECHNICAL
GUIDE
DRILLING**



Drilling Technical Guide

Proper Application and Usage of Drilling Tools

Part 1: Drill Basics..... 3

1.1	Types of Drills	3
	By Body Type	3
	By Shank Type	4
	By Flute	4
	By Flute Cross Section	5
	By Length	5
	By Application	6
1.2	Terminology	7
1.3	Structure and Function	7
	Flute Length	7
	Flute Form	8
	Web	8
	Helix Angle	9
	Point Angle	9
	Point Design	10
	Thinning	11
	Primary Relief Angle	12
	Shank	13
1.4	Substrates	14
	High-Speed Tool Steel	14
	Carbide	15
1.5	Surface treatment	16
	Steam oxide	16
	Nitride	16
	Coating	17

Part 2: Cutting Performance 18

2.1	Cutting Mechanism	18
2.2	Chip Evacuation	19
2.3	Hole accuracy	20

Hole Expansion	20
Rifling and Circularity	21
Special Work Piece Shapes	23
Burring	23

Part 3: Cutting Parameter 26

3.1	Formula for Cutting Parameter	26
3.2	Coolant	26

Part 4: Regrind 28

4.1	When to Regrind?	28
4.2	How to Regrind	29

Part 5: Applications 29

Part 6: Drilling Tips for Special Work Shape 32

Part 7: Drilling Tips for Difficult to Machine Material 33

Part 8: Troubleshooting 34

Part 1: Drill Basics

1.1 Types of Drills

A drill is a hole-making tool that has cutting edges at the tip, and a groove to evacuate chips to the outside of hole. This “groove” is commonly referred to as the drill “flute”.

By Body Type

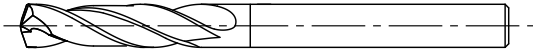
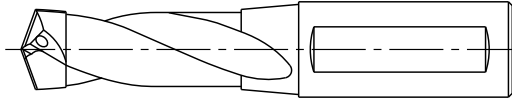
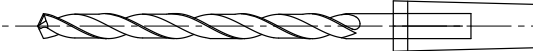
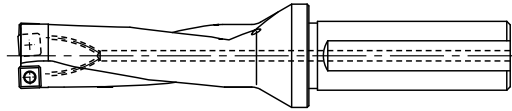
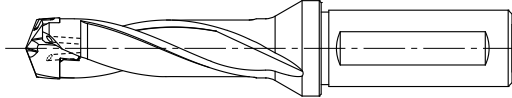
Drill Type	Drill Design
Solid Drill	The entire drill is made of the same material
	
Solid Point Drill	Only the point is made of carbide, and brazed onto the body
	
Combined Drill	A drill in which a solid drill is brazed or inserted into a larger shank
	
Indexable Drill	The cutting edges are perishable inserts
	
Exchangeable Head Drill	The tip is exchangeable and locks into the body
	



Drilling Technical Guide

Proper Application and Usage of Drilling Tools

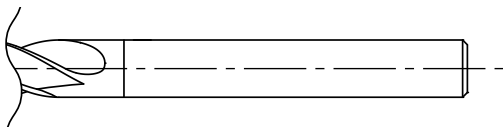
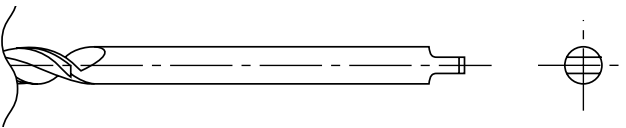
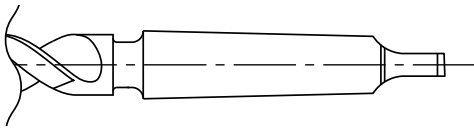
By Shank Type

Drill Type	Drill Design
Straight Shank	Diameter of the shank remains the same
	
Shank with Tang	Straight shank with tang
	
Taper Shank	Morse Taper
	

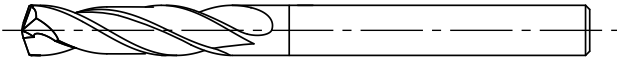
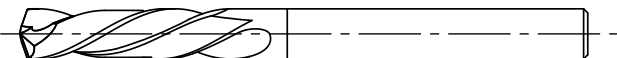
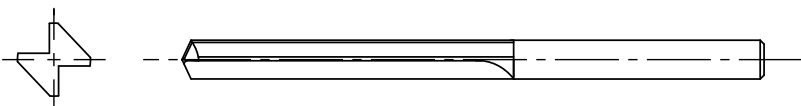
By Flute

Drill Type	Drill Design
Right Handed Helix	For most conventional drilling applications
	
Left Handed Helix	For turning machines
	
Straight Flute	For non-ferrous material
	
Variable Lead Drill	Drill has variable lead flute
	

By Flute Cross Section

Drill Type	Drill Design
Internal Coolant Through	Drill has internal coolant through hole(s)
Sub-land	Drill has 2 or more leading edges
Double Margin	Drill has 2 margins on 1 land
Parabolic Flute	Drill has bigger core diameter and thinner land width. Commonly for deep hole drilling



By Length

Drill Type	Drill Design
Regular	General purpose
Long	Longer flute and overall length than a regular drill
Stub	Shorter flute and overall length than a regular drill

Drilling Technical Guide

Proper Application and Usage of Drilling Tools

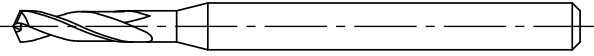
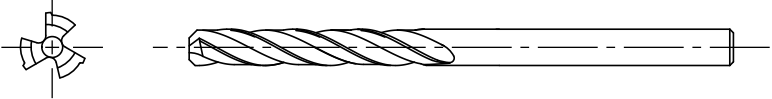
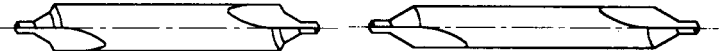
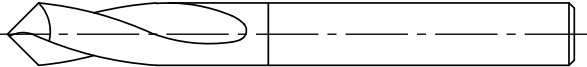
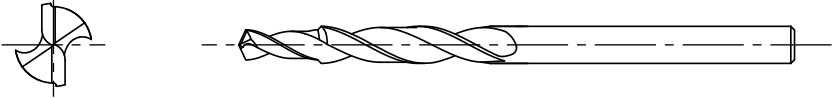
By Application

Drill Type	Drill Design
Standard Drill	Straight shank (same cut. Ø & shank Ø); size-dependent
	
Core Drill	For finishing operation of holes. Three and four fluted drills are commonly used
	
Center Drill	Drill for centering
	
Spot Drill	Drill for centering and chamfering
	
Step Drill	Drill has two or more diameters to drill and chamfer at the same time
<p>Step drill</p>  <p>Sub-land step drill</p> 	
Drill for Construction	Drill for steel frame
	

1.2 Terminology

Figure 1-1: Technical Terms of Twist Drills

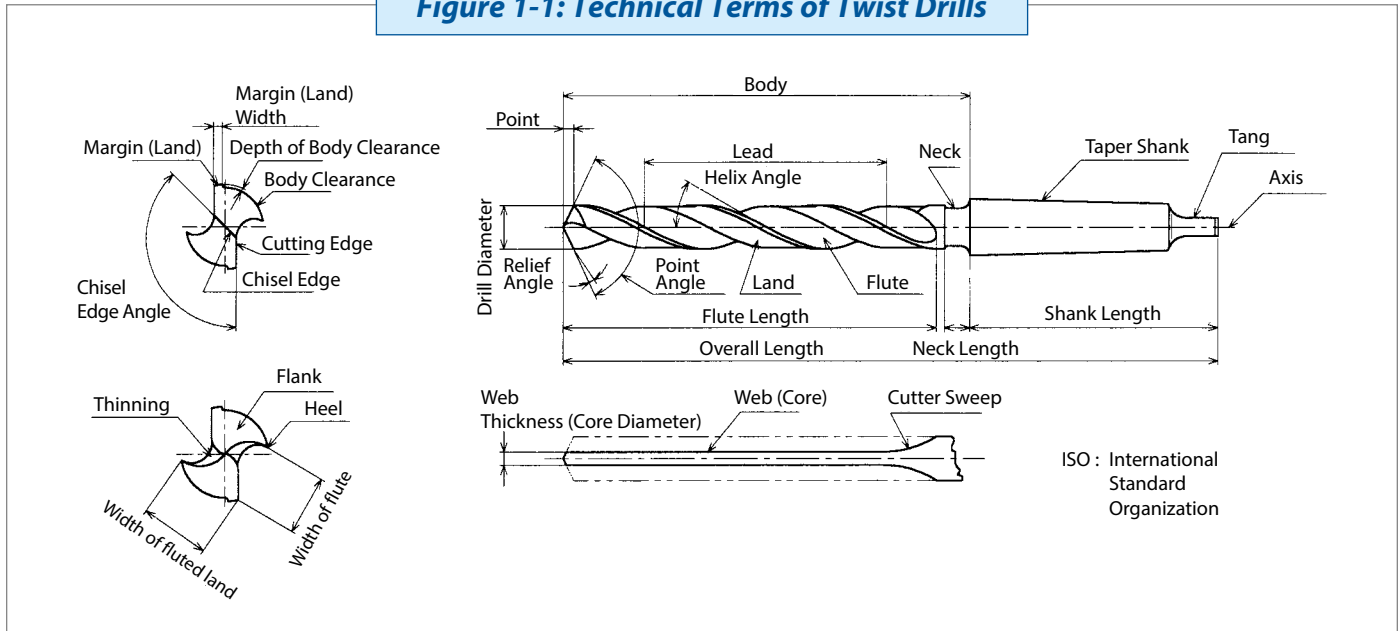

1.3 Structure and Function

A drill has a simple shape at first glance, but each part has a close relationship with each other. Each part affects the tool's overall machining efficiency, tool life, and hole accuracy. This section describes the shape and function of each part.

Flute Length

The flute length of the drill has great influence on tool life, along with the recommended cutting speed, feed rate, selection of cutting fluid, etc. It should be set as short as possible with considerations for hole depth, any bushings, and also number of regrinds. Shortest possible flute length is recommended because the longer the flute length, the longer the rigidity, and the easier it is for the drill to bend and increase the runout. The longer the flute length, the likelier it is to cause an unstable cutting state. As a rule of thumb to set an appropriate drill flute length, use this calculation: [Hole Depth (including clearance between the bushing and workpiece, as well as the actual bushing thickness itself)] + [1.5 x D (drill diameter)] + [re-grinding amount] + [penetration length].

Figure 1-2: Flute Length

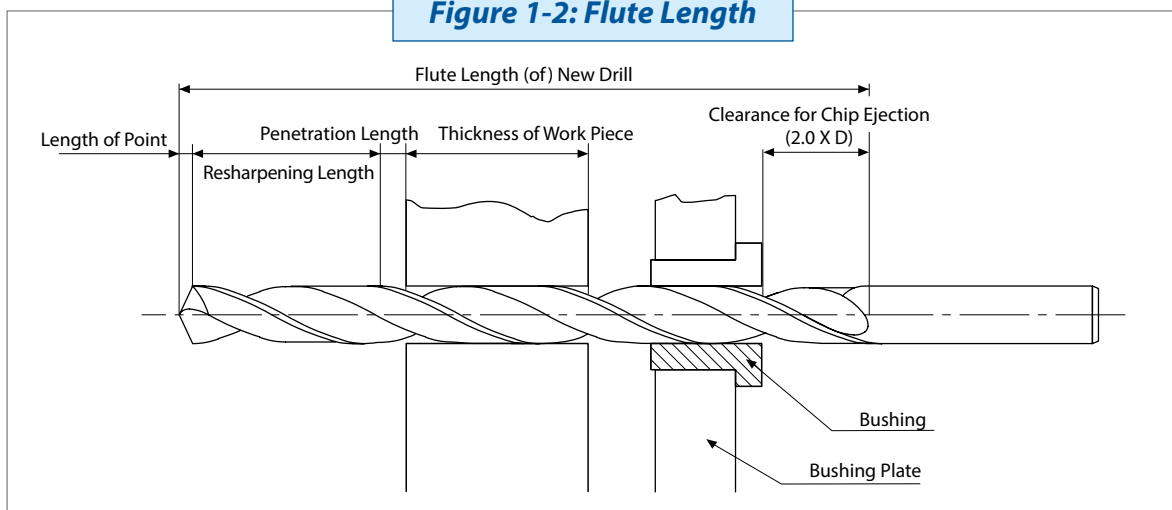

Flute Form

Flute form significantly influences drill performance. The flute has a rake form cutting edge, with a helix angle and a point angle. Chips are ejected up and out of the cutting area through the flute, while lubricant is simultaneously supplied through the flute. The deeper the drilling depth, the more noticeable the effects of the flute form.

Figure 1-3: Flute Form

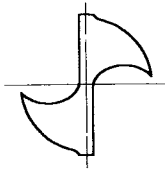
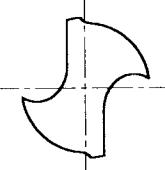
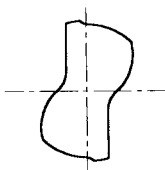
Type	Form	Web Thickness	Features & Applications
Conventional		0.1-0.25D	Large chip room for general purpose
High Rigid		0.2-0.35D	Highly rigid form low thrust at high feed rates
Parabolic		0.3-0.45D	Both high rigidity and large chip room deep holes

Web

The larger the web thickness, the higher the rigidity. However, the larger the web thickness, the smaller the chip room. For deep hole drilling, large web thickness prevents drill breakage and/or curved hole. Parabolic flute form provides smooth chip evacuation, with high rigidity. Also the larger the web thickness, the larger the thrust force, so additional grinding must be done to the the point thinning to reduce the thrust force.

Figure 1-4: Web Thickness

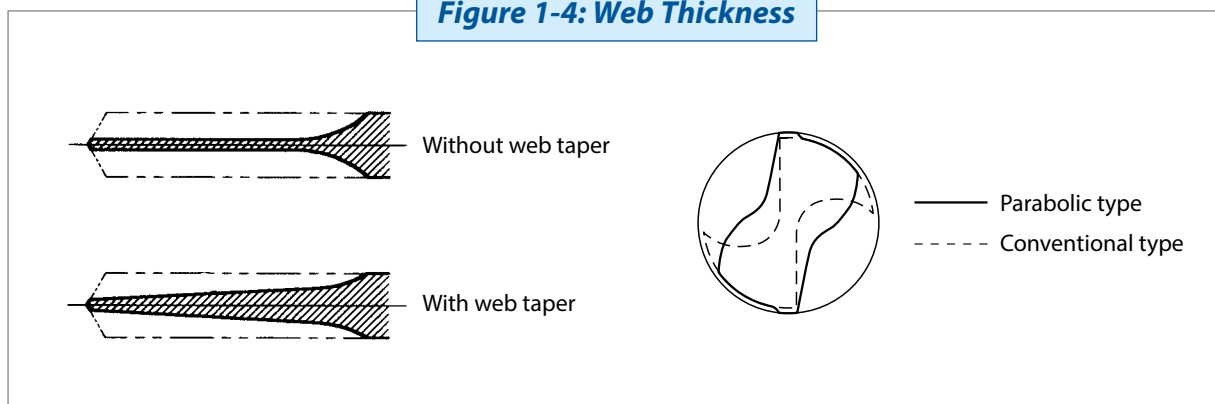

Helix Angle

Helix angle is the rake angle of the cutting edge. The cutting resistance decreases as the helix angle increases. But if the helix angle is too high, the rigidity of the drill cutting edge decreases. Therefore, conventional drills have a helix angle of approximately 30°. In general, a lower helix angle is suitable for harder work materials, while a higher helix angle is most appropriate for softer work materials. Because smaller diameter drills need absolute rigidity of the body, a low helix angle is almost always recommended in those applications.

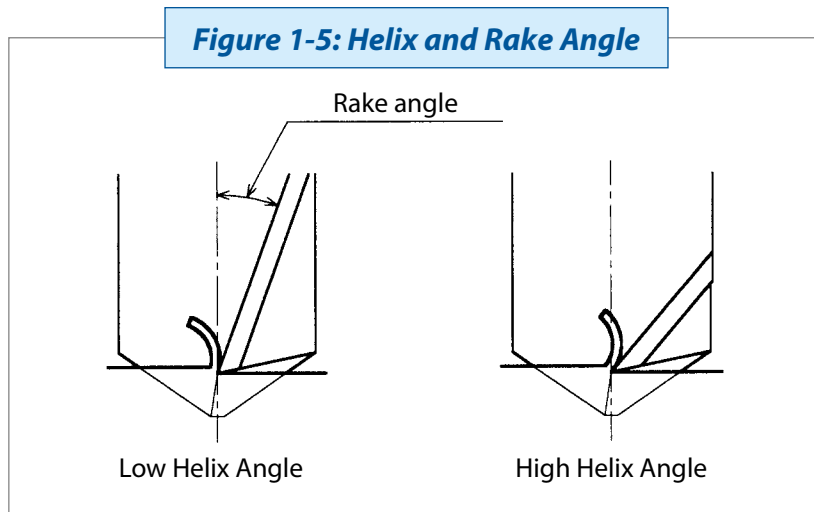

Point Angle

The point angle of a drill is generally ~118°. Point angle affects thrust load and torque. The larger the point angle, the larger the cutting thrust. It also affects the length of the cutting edge and the subsequent thickness of the chips. Point angle should be selected according to the work material and the drill diameter.

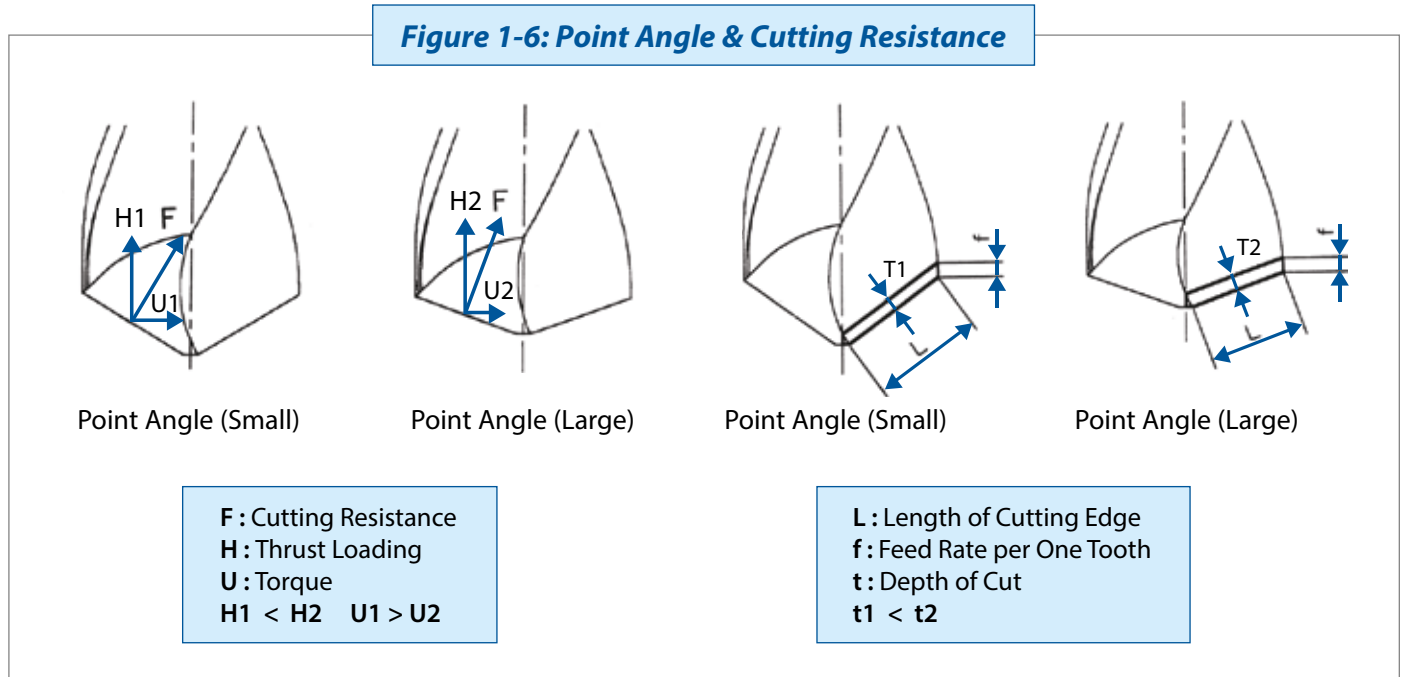





Drilling Technical Guide

Proper Application and Usage of Drilling Tools

Point Design

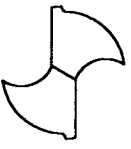
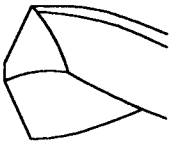
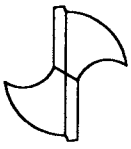
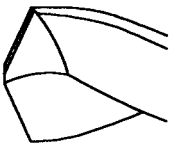
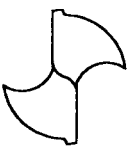
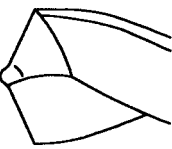
The cutting edges of a drill are formed by adding a relief to the tip of the flute. The following table explains the variety of designs and their applications. Also, because the re-grinding of the drill is done only at the tip, the difficulty of regrinding each geometry is also an important point to consider.

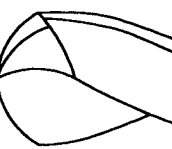
Figure 1-7

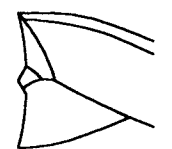
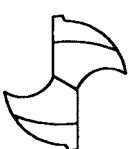
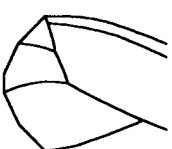
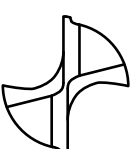
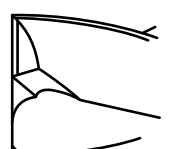
Type	Design		Features & Applications
Conical			<ul style="list-style-type: none"> • Conventional drill. • For general purposes.
Four Facet			<ul style="list-style-type: none"> • Good centripetal force. • Easy to grind a precise cutting edge. • Recommended for small drills.
Spiral			<ul style="list-style-type: none"> • Good centripetal force. • Large clearance of the chisel edge. • Recommended for soft work material.
Radial Lip			<ul style="list-style-type: none"> • Effective for good surface finish and prevention of burr and edge chipping on the work piece. • For cast iron, aluminum castings.
Chit			<ul style="list-style-type: none"> • Effective for prevention of burr and vibration when drilling sheet metal. • For structural steel and sheet metal.
Double Angle			<ul style="list-style-type: none"> • High rigidity on outer corner • For hardened work material, abrasive material, cast iron.
Flat			<ul style="list-style-type: none"> • Use for spot drilling and counterboring. • Effective for prevention of burrs. • Ideal for drilling on non-flat surfaces.

Thinning

The chisel edge has a small rake angle and no chip pocket space. Without thinning, very large thrust force is generated in comparison to the cutting edges, and makes material penetration difficult.

Thinning reduces the thrust force by shortening the chisel edge, and adding sharpness to the rake angle. This allows for easier cutting (less resistance), good chip removal, and longer overall tool life. Typical thinning designs are shown in the following table.

Figure 1-8

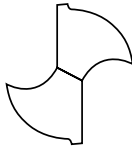
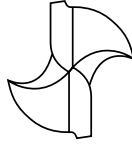
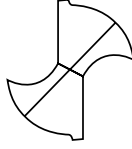
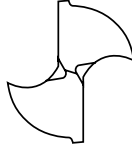
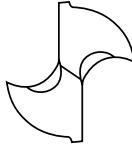
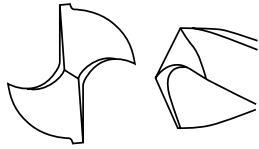
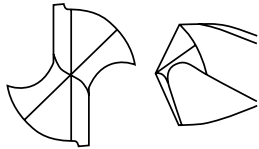
Type	Design	Features & Applications
No thinning		<ul style="list-style-type: none"> • For general purposes.
R-type		<ul style="list-style-type: none"> • Good penetration. • Compact chip creation. • Reduced thrust force.
X-type		<ul style="list-style-type: none"> • Good penetration. • Applied to larger web Ø drill. • Reduced thrust force.
N-type		<ul style="list-style-type: none"> • Wide chip pocket. • Apply to smaller web Ø or smaller point angle. • Stronger tip.
S-type		<ul style="list-style-type: none"> • Apply to small web Ø or small point angle. • Stronger tip. • Easy to regrind.
W-type		<ul style="list-style-type: none"> • For hard material. • Prevents chipping. • Strong tip. • Strong cutting edge.
Special for High Hardened Material (W+R)		<ul style="list-style-type: none"> • For hard material. • Prevents chipping. • Reduces thrust force. • Strong cutting edge.

Primary Relief Angle

The primary relief angle generally ranges from 6°-15°. For drilling hard material, or using drills with large a diameter and a large point angle, the relief angle should be small. For drilling soft work materials, or using drills with a small diameter and a small point angle, the relief angle should be large.

When the relief angle is too small, welding can easily occur. When the relief angle is too large, chipping and/or chattering can occur due to the weakened cutting edge.

Figure 1-9: Relief Angle and Tool Life

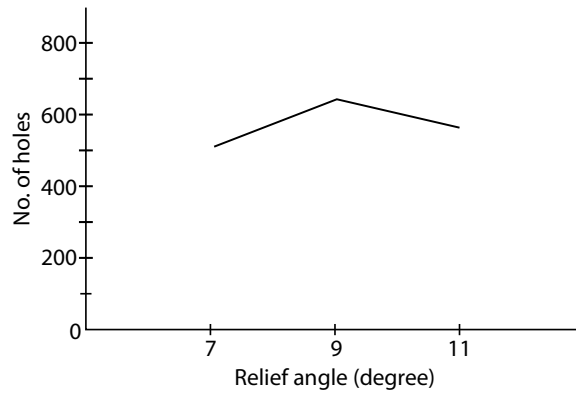
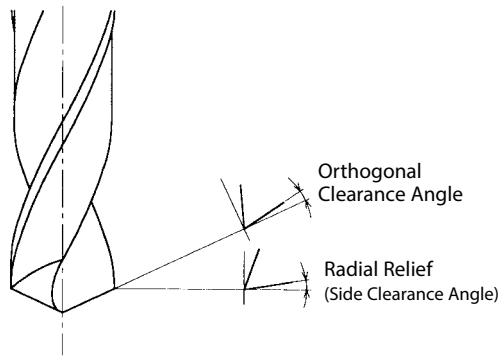

Drill	Work Material	Length Hole	Speed	Feed	Lubrication	Machine
HSS-Co	Medium carbon steel 96HRB (JIS S45C, AISI 1045)	25mm	25m/min.	0.15mm/rev.	Emulsion (10x)	Vertical NC boring machine

Shank

Figure 1-10

Shank		Holding method	Feature
Shape	Outlook		
Straight Shank		Hydro chuck Shrink fit	High precision High gripping force
		Double tapered collet	High gripping force High rigidity
		Single tapered collet	General purpose
		Pull screw	High gripping force
		Single side lock	Easy on/off
		Double side lock	Easy on/off
		Combination	Easy on/off
	Tapered Shank	Tapered	
with Pull screw			High gripping force
with Tang			Easy on/off.
with Screw lock			High gripping force

Drilling Technical Guide

Proper Application and Usage of Drilling Tools

1.4 Substrates

Tool substrate material includes various tool steels, cemented carbides, cermets, ceramics, CBN, and synthesized diamond. High-speed tool steel and carbide are the most commonly used materials for drill substrates.

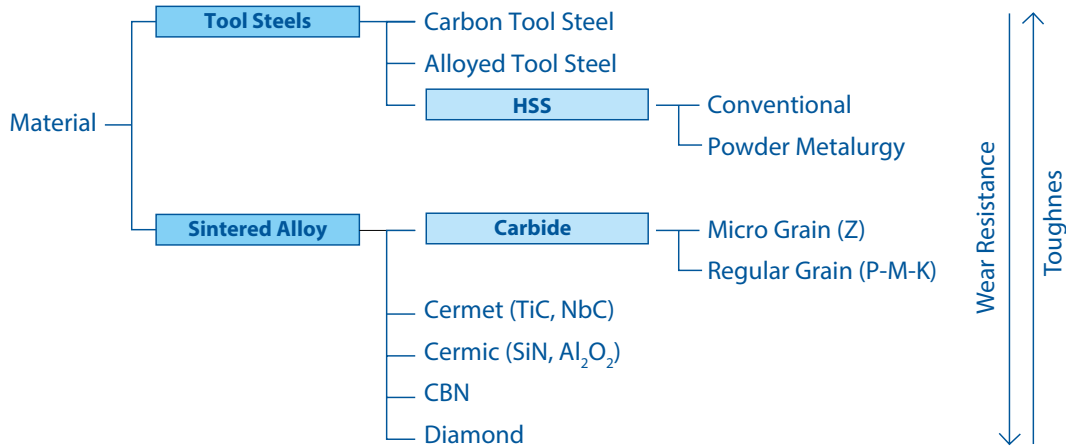

High-Speed Tool Steel

SKH51 is widely used as a material for HSS general-purpose drills. HSS with Cobalt, SKH55, SKH56 and SKH59 and SKH57 are used for high speed, high efficiency machining and long tool life. High-Vanadium and high-cobalt HSS, as well as high-cobalt powdered HSS tend to be utilized for difficult-to-machine materials.

Figure 1-11: Drill's Material

Applications	DIN	JIS	AISI	Nominal Composition (%)						
				OSG	C	W	Mo	Cr	V	Co
For conventional use	S 6-5-2	SKH 51	M 2	-	0.8	6	5	4	2	-
	S 6-5-3	SKH 53	M 3-2	HSSE	1.2	6	5	4	3	-
	S 6-5-2-5	SKH 55	M 35	HSS-Co	0.8	6	5	4	2	5
	-	SKH 56	M 36	HSS-Co	0.9	6	5	4	2	8
	-	SKH 58	M 7	HSS	1	1.8	8.8	4	2	-
For difficult-to-machine materials	-	SKH 57	-	-	1.2	10	3.5	4	3.4	10
	S 2-10-1-8	SKH 59	M 42	-	1.1	1.5	9.5	3.8	1.2	8
	-	-	M 43	-	1.25	1.8	9	3.8	2	8.3
Powder metallurgy HSS for difficult-to-machine materials	S 12-1-4-5	SKH 10	T 15	CPM	1.5	12	-	4	5	5
	ASP2030	-	-	-	1.27	4.2	5	6.4	3.1	8.5
Powder metallurgy HSS for high speed cutting & heat treated materials	-	-	-	XPM	V: 5, CO: 10 (patent pending)					

The influence of the alloy elements

	Cr	W	Mo	V	Co
Hardness	↑	↑	↑	↑	•
Impact resistance	→	→	↑	→	↓
Heat resistance	↓	↑	↑	↑	•
Wear resistance	↑	↑	↑	•	↑

• Increase extremely ↑ Increase → No change ↓ Reduction

Material	HSSE	HSS-Co	XPM	Carbide
Compound	HSS+3%V	HSS+8%Co	HSS P/M 10% Co & 5% V	Tungsten + Cobalt
Advantage	Wear Resistance	High Hot Hardness	High Wear Resistance & Hot Hardness	Extreme Wear Resistance & Hot Hardness

Carbide

Cemented carbide is generally a very hard compound made of fine particles of Tungsten Carbide (WC), Titanium Carbide (TiC), and Cobalt (Co). Cobalt is sintered into the mix as a binder. Overall, carbide has excellent wear resistance.

To improve material properties depending on the purpose of use, add Titanium Carbide (TiC) or Tantalum Carbide (TaC). ISO standard divides carbides into two types, HW and HF, based on the average particle size of WC.

Carbides are further classified into three types (P-type, M-type, K-type) according to the chip shape of the work material. The HW-series carbide is characterized by micro-grain particle size, giving it its hardness properties, which makes it best suited for drilling cast iron and non-ferrous materials.

The HF-series carbide is characterized by sub-micrograin particle size, giving it its toughness properties, which makes it best suited for drilling steels.

Cemented carbide has less toughness than HSS, so chipping of the cutting edge may occur. This can be addressed by using ultra-fine particle cemented carbide (HF-type), which will greatly improve toughness and chipping resistance.

To further improve cutting performance in steels and other difficult to machine materials, PVD coatings can be added to the surface of the drill.

Cemented Carbide (JIS B 4053 : 2013)

Material	Material Classification
HW	Consists of metal and hard metal compound, in which the main component in the hard phase is tungsten carbide and the average grain size of the hard phase grains is less than 1 µm. Generally called ultra-fine grained cemented carbide.
HF	
HT	Consists of a metal and a hard metal compound, the main component of the hard phase is titanium or tantalum (niobium) carbide, carbonitride, or nitride, with a small amount of tungsten carbide. Generally referred as cermet.
HC	A single layer of carbides, carbonitrides, nitrides (titanium carbide, titanium nitride, etc.), oxides (aluminum oxide, etc.), diamond, diamond-like carbon, etc. is added to the surface of the above cemented carbides. Diamond and diamond-like carbon are chemically or physically coated on the surface of the above cemented carbides in one or more layers. Generally referred as coated cemented carbides.

Classification of Carbide Cutting Tools (JIS B 4053 : 2013)

ISO Identification	Identification Color	Work Material	Classification Symbol	Cutting Speed	Feed Amount	Abrasion Resistance	Toughness
P	Blue	Steel (except for Austenitic stainless steel) Casted Steel	P01, P05	High Speed ↓	↑ High Feed	High ↓	↑ High
			P10, P15				
			P20, P25				
			P30, P35				
			P40, P45				
			P50				
M	Yellow	Stainless Steel Austenitic Austenitic/Ferritic Stainless Steel Casted Stainless Steel	M01, M05	High Speed ↓	↑ High Feed	High ↓	↑ High
			M10, M15				
			M20, M25				
			M30, M35				
			M40				
K	Red	Ductile Cast Iron Gray Cast Iron Spheroidal Graphite Cast Iron Malleable Cast Iron	K01, K05	High Speed ↓	↑ High Feed	High ↓	↑ High
			K10, K15				
			K20, K25				
			K30, K35				
			K40				

Composition and Function of Cemented Carbide

Factor	Effects based on carbide properties
Co. amount	- Used as a binder, has a hardness as soft as 200HV. - Higher the Co content, the lower the compressive strength and longitudinal modulus and high impact resistance.
WC grain size	- If the Co content is kept constant, the smaller the grain size of the WC, the higher the hardness. - Tensile strength peaks at a certain grain size and decreases whether the grain size increases or decreases. - WC hardness is around 2100HV.
Added Carbide	- TiC is hard and heat resistant and also improves the hardness and wear resistance. However, the tensile strength and chipping resistance will decrease. - TaC inhibits the grain growth of TiC, improves the chipping resistance and improves the oxidation resistance of cemented carbide.

1.5 Surface treatment

The surface treatment of a drill is roughly divided into steam oxide, nitriding, coating, and electrodeposition. They have the following characteristics.

Type	Characteristics	Purpose	Application
Steam Oxide	<ul style="list-style-type: none">• Fe₃O₄ film• Retain coolant with porous surface• Reduce friction• Prevent welding	<ul style="list-style-type: none">• Anti-welding	<ul style="list-style-type: none">• Stainless steel• Soft and ductile steel• Not suitable for aluminum
Nitride	<ul style="list-style-type: none">• Treated thickness 30~50µm• Surface hardness 1000~1300Hv	<ul style="list-style-type: none">• Increase• Wear resistance	<ul style="list-style-type: none">• High tensile steel• Cast Iron• Aluminum die casting
Coating	<ul style="list-style-type: none">• Thickness 3-5µm• Surface hardness over 2000Hv• Reduce friction• Prevent welding	<ul style="list-style-type: none">• Increase wear resistance	<ul style="list-style-type: none">• Hard material• Stainless steel• HRSA
Electrodeposition	<ul style="list-style-type: none">• Deposit diamond or CBN• High wear resistance	<ul style="list-style-type: none">• Increase wear resistance	<ul style="list-style-type: none">• Hard and brittle material• Like ceramic

Steam oxide

This process produces a film on the surface of the drill. The tools are heated in a steam furnace for 30 to 60 minutes at 500 to 550°C (932-1040°F). The benefits of this treatment include reduced heat from friction and improved welding and build up prevention. Therefore, steam oxidizing is most effective for drilling low carbon steel or stainless steel (known for causing welding).

Nitride

Nitriding is a surface hardening treatment method in which Nitrogen is diffused into the surface layer of steel (500 to 600°C). It hardens the surface to improve wear resistance, reduces coefficient of friction, and extends tool life. It is effective for machining cast iron (which is abrasive and requires high wear resistance tooling). Be cautious in applications and with materials that easily cause chipping.

Coating

Coating is a method of adding hardness to the surface of the tool by utilizing a hard compound such as TiN, TiCN, or TiAlN. The typical thickness of the coating starts at 1 micron and can increase up to 5 micron or more. Currently, there are two main types of coating, (1) CVD (chemical vapor deposition) and (2) PVD (physical vapor deposition). Generally, PVD has a lower processing temperature (~500°C) versus CVD (~1,000°C), which prevents the substrate material from softening. And thus, coatings can be applied to HSS, carbide, and brazed-carbide tools. More recently, these are multi-layer coatings with high cracking resistance.

Part 2: Cutting Performance

2.1 Cutting Mechanism

A drill usually has two cutting edges. The work material is cut when the drill rotates. The following figure illustrates the cutting process of a drill without thinning.

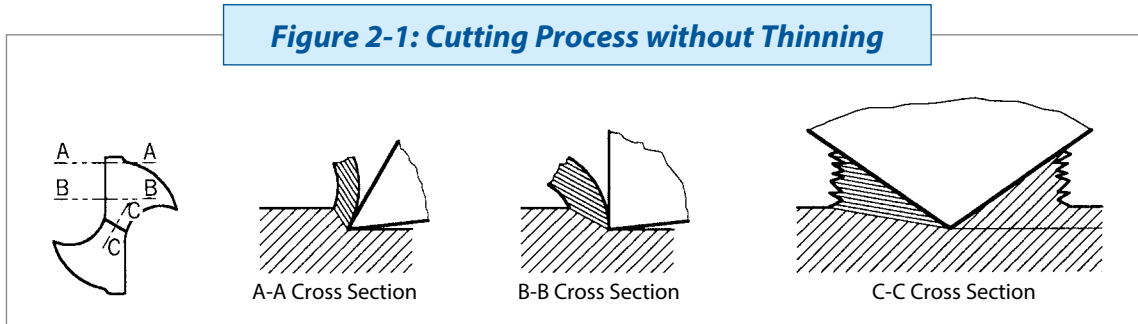

The drill's rake angle increases from the center to the outer cutting edge. The cutting speed also increases at the outer cutting edge as the diameter is larger at that point. Without a thinning grind, the drill's chisel edge is long, and there is also no chip pocket room. This results in decreased cutting speed capability and high thrust force. Appropriate thinning is important in order to reduce the thrust force and improve chip ejection. The following figures show the cutting process for a drill with R-thinning:

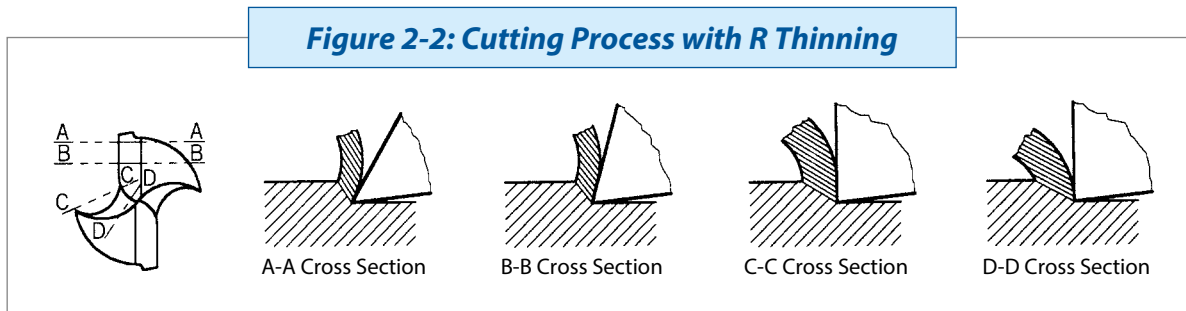

In the following case study, the drill has R-thinning, and shows a reduction in thrust force of 25-40% when compared to other drills.

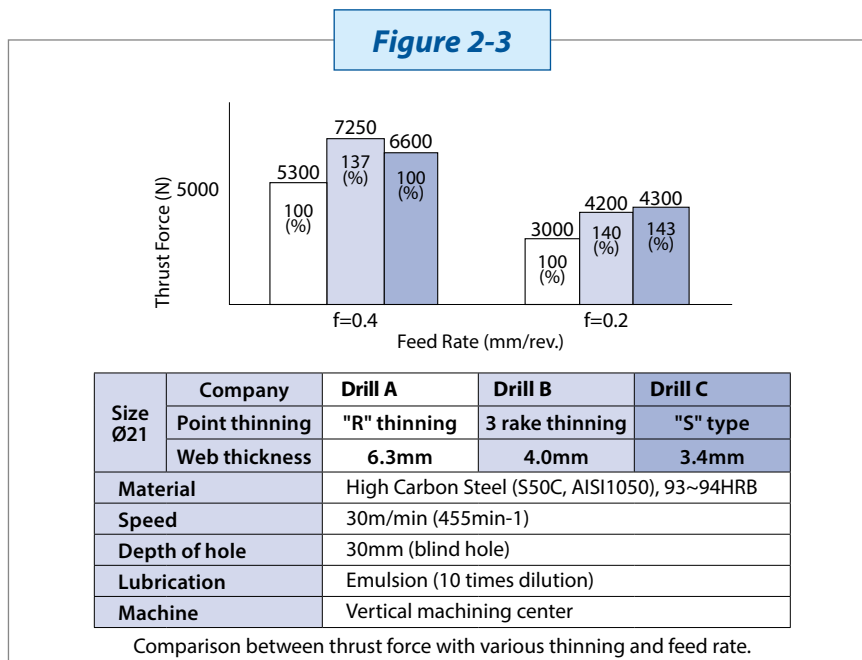

The below graph shows that the thrust force on the lip of the drills is the same for the EX-Gold drill versus a similar drill without thinning, but that the drill with the thinning (i.e. reduced area of the chisel edge), decreases the required thrust force overall.

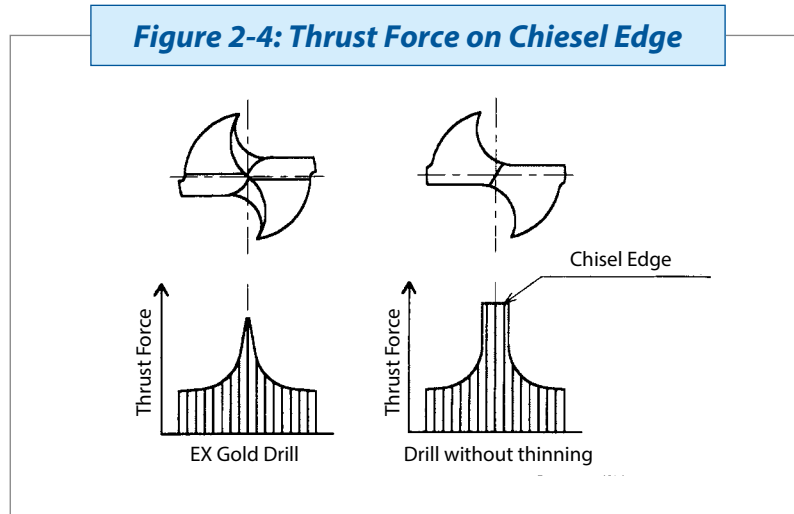

2.2 Chip Evacuation

Drilling requires cutting in narrow holes and ejecting chips through narrow grooves. Therefore, the chip shape is very important for the cutting performance of the drill. Chip shapes are roughly classified as follows.

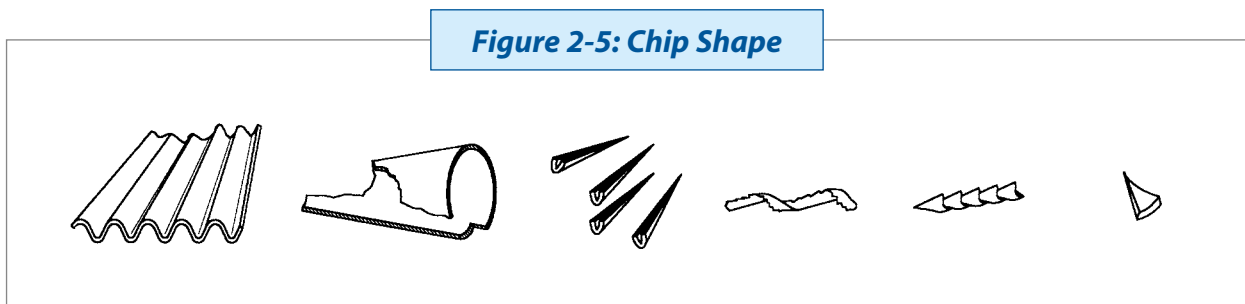

Improper chip shape causes the following problems:

- (a) Stacking of small chips causes breakage, resulting in reduced life, reduced hole accuracy.
- (b) Long chips cause tangling on the drill (flute & shank), resulting in breakage.
- (c) Long chips prevent the coolant supply from reaching the cutting zones.

Various methods are used to properly divide or break chips to eliminate chip packing and to improve efficiency. When machining metals, the chip thickness and chip shape will change as the feed per tooth increases. The range of thickness and shape will vary depending on the work material and cutting fluid. Stable drilling with good chip control can be achieved by adjusting to a suitable cutting condition.

Table 2-6: Methods for Breaking Chips

Methods	Note
Increase the feed rate	Must have rigid drill and a rigid machine holder
Adopt step feeding	Process time and friction wear will increase
Grind chip breakers on drill's cutting edge	Difficult to add breakers on edge
Grind a thinning	Requires a special grinding machine

Drilling Technical Guide

Proper Application and Usage of Drilling Tools

The R-thinned drill (like EX-Gold) cuts chips by the following mechanism and shows high cutting performance.

- (a) Chip generation starts at the cutting edge, and curls in toward the center of the drill due to the cutting velocity difference between the center and the outside edge of the drill.
- (b) The flute shape and wall of the cut hole force the chip to curl.
- (c) Chips are twisted because of the spiral-shaped flute. The crack on the drill chip grows until it reaches the outer edge of the drill.
- (d) Chip flow is different at the inside of the chip crack and outside of the chip crack. This difference causes the crack to propagate even further.
- (e) The chips separate.

Figure 2-7: Chip Breakage Process with R Thinning

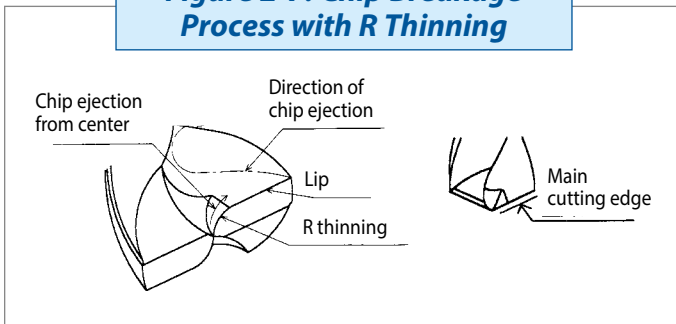
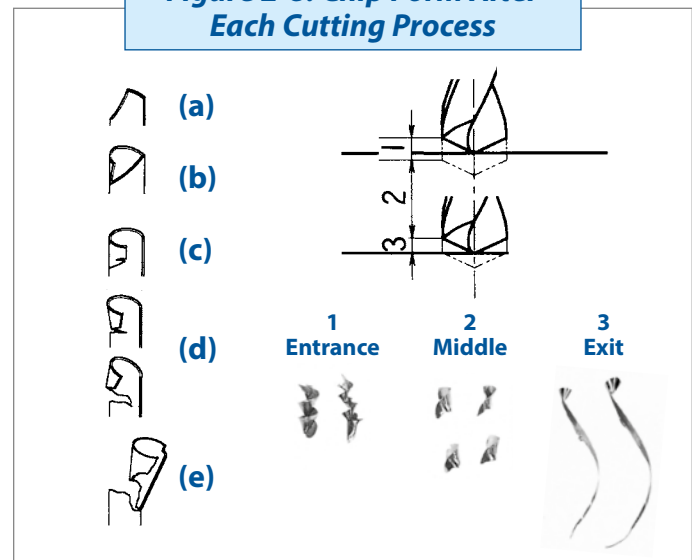

Figure 2-8: Chip Form After Each Cutting Process



2.3 Hole Accuracy

Parts of hole accuracy include diameter size, hole position, bending (straightness) of the hole, roundness, and surface roughness. Although slightly different, burrs on the exit side are always a problem in post-processing.

In machining, high rigidity/precision tools, work material, and machines are important for stable and high-precision machining of holes, but in drilling, the below factors affect the accuracy.

- (a) Runout of the tool at setting (holder).
- (b) Cutting conditions (cutting speed, feed rate, cutting fluid, etc.)
- (c) Drill shape (length, tip shape, web shape).
- (d) Shape of work material (condition of machining surface, shape of entrance/exit, thickness, clamping condition, etc.)

Hole expansion

The expansion of drilled holes are caused by runout and vibration of the tool during machining. The below data shows the effect of tool runout to the hole diameter and hole position. Even with a high-rigidity and high-precision drill, if the runout from tool setting is large, the holes will expand and the hole position will deteriorate. This tendency becomes even greater with general-purpose drills with low rigidity.

Figure 2-9: Effects of Deflection

Run out after chucking: 0.034mm
 Run out after chucking: 0.112mm

Drill	Ø6.8 HSS-Co
Work Material	Medium Carbon Steels (S45C, AISI 1045)
Length of Hole	25mm (through)
Speed	30m/min
Feed	0.2mm/rev. (non pecking)
Lubrication	Water soluble oil

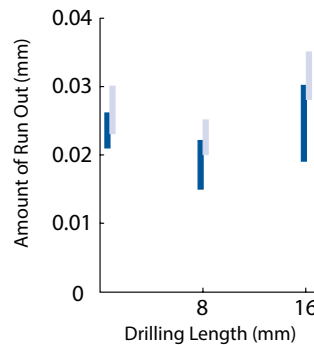

Run out after chucking: 0.034mm

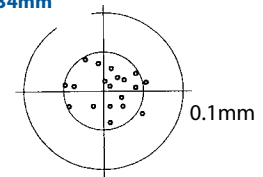

Run out after chucking: 0.112mm

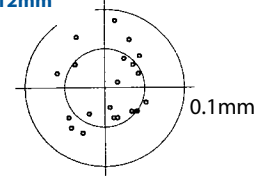

Since it is difficult to measure and adjust runout when drilling small diameter holes, use a drill whose shank diameter is larger than the cutting diameter. The relationship between the drill's lip height and the resulting hole expansion is below. The smaller the lip height difference, the smaller expansion of the hole.

Figure 2-10: Effects of Lip Height Differentials

Drill	Ø1.15 HSS-Co
Work Material	Medium Carbon Steels (97~98HRB)
Length of Hole	3.5mm (blind)
Speed	30m/min
Feed	0.04mm/rev. (non pecking)
Lubrication	Water soluble oil

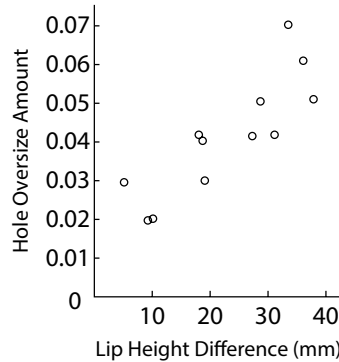

Lip Height Difference: Difference in height between the major cutting edges when the drill is rotating.

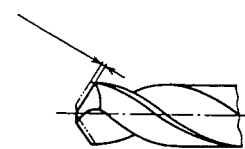

Rifling and Circularity

A common issue with drill hole accuracy is an effect known as rifling, which typically appears as a polygonal (and non-circular) drilled hole. Typically this mechanism is related to vibration, which causes an imbalance of cutting for each segment of the theoretical circle the drill machines. The drill cutting edge is not machining the same amount of material in each 60deg segment of the circle, resulting in more linear movement and creating a triangular or pentagonal shape. Rifling is most easily seen as a long, helical streak along the length of the hole. However, in many cases, the rifling will become less severe deeper in the hole, as the drill's margin begins to dampen the vibrations induced by drilling. This may result in a funnel-shaped rifling near the hole entry that resolves into a smooth finish and accurate roundness deeper in the hole.

Figure 2-11

Rifling

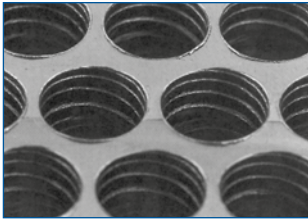

Behavior of drill bottom

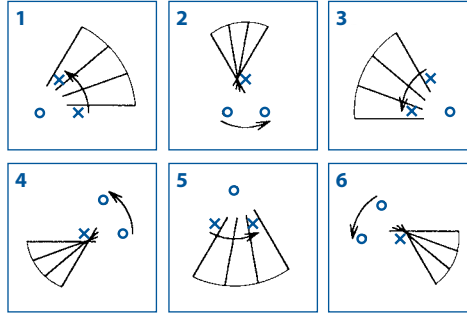
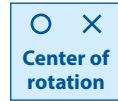
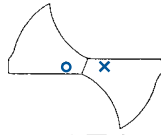

Funnel-shaped hole

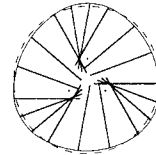
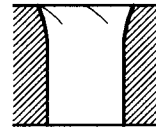

Combination of movements from figures 1 through 6

It is thought that pentagonal and heptagonal holes are created in the same process.

Methods to eliminate this phenomenon include:

- 1) Minimize runout at the time of installation.
- 2) Check lip height.
- 3) Increase rigidity of the drill.
- 4) Increase feed rate.
- 5) Reduce the relief angle.
- 6) Change the thinning shape.

Figure 2-12: Run Out of Hole Size

Relationship between feed rate and circularity

Drill	(Ø22mm HSS-Co)
Material	Medium Carbon Steel (82-97HRB)
Depth of Cut	20mm (through)
Speed	25m/min.
Lubrication	Emulsion (10x)

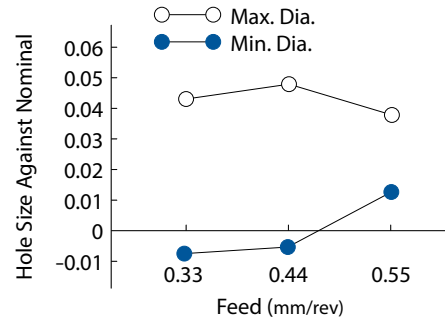
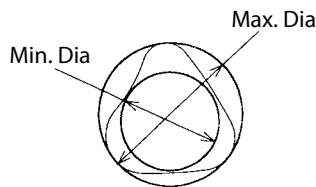

Relationship between feed rate and rifling

Drill	(Ø9mm HSS-Co)
Material	Mild Steel
Cutting Speed	33.9m/min
Feed Rate	0.12-0.24mm/rev
Lubrication	Emulsion

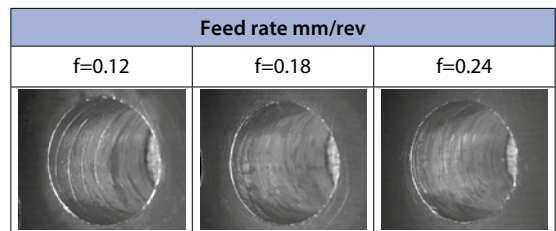
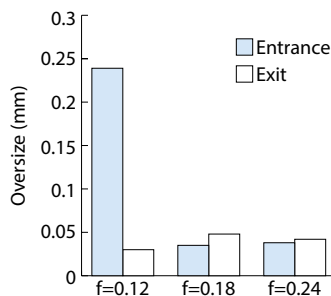

Special Work Piece Shapes (sloped or curved surface, etc.)

When drilling special forms of material surfaces (curved, interrupted..), we recommend:

1. Centering - use a spotting drill or a center drill.
2. Counterboring - for slanted surfaces.
3. Increasing drill rigidity - use a stub drill or a drill with a large web/core thickness such as the AD or EX-GDS.
4. Use drills with thinning.
5. Reduce the feed rate.

The below cutting data shows how utilizing a conventional drill versus a stub length drill with R-Thinning versus a spot drill can affect the true position of a drilled hole on a 15° inclined surface. Additionally, the data also shows how increasing feed in each scenario affects the accuracy. The positional accuracy is significantly improved by using the spot drill and stub drill versus a conventional length drill.

Figure 2-13: Drilling on 15° Inclined Surface

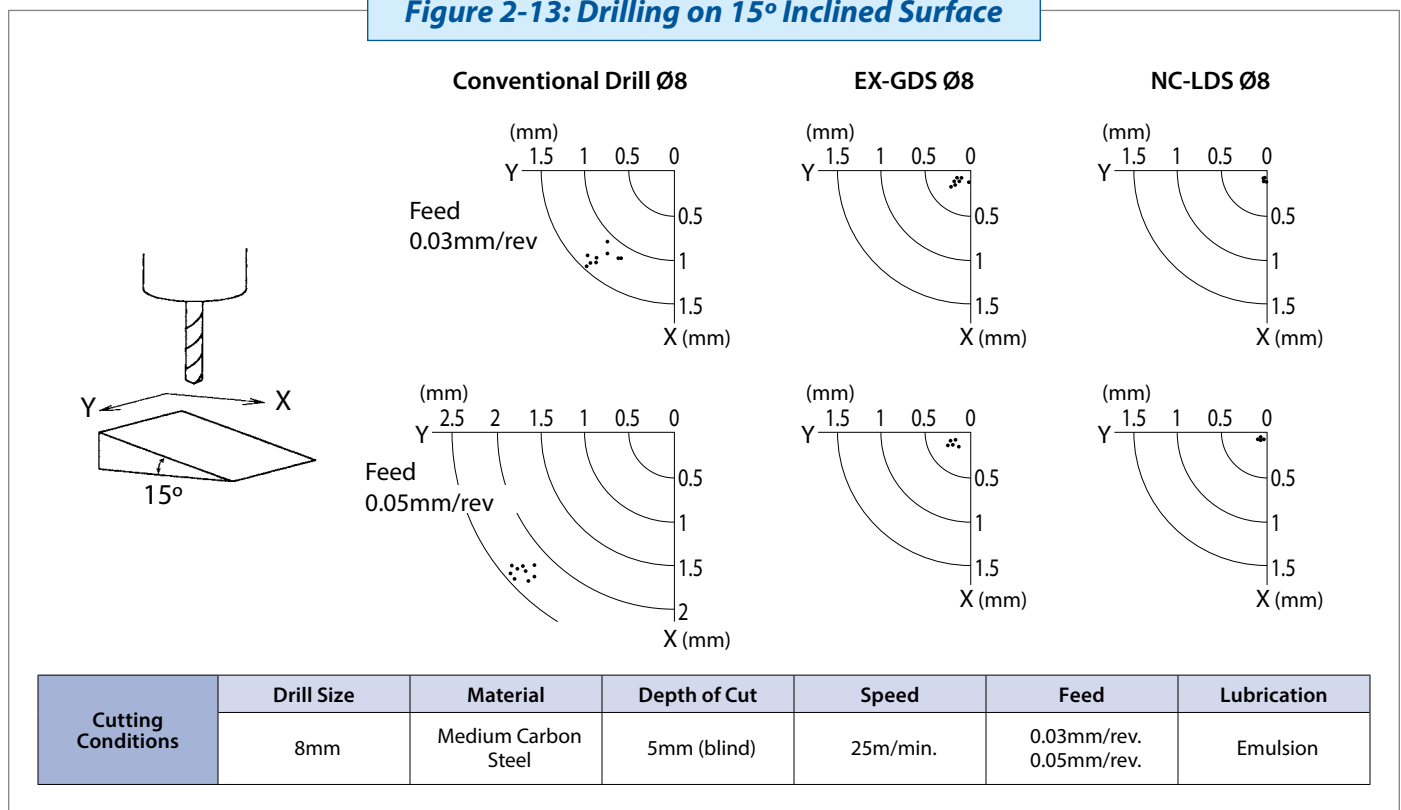

Burring

Burrs are generated at the entrance and exit areas of the hole. Burrs at the exit are usually larger than those at the entrance. Major burrs are generated by elastic deformation and a rolling over of the material.

Figure 2-14: Roll-Over Burrs

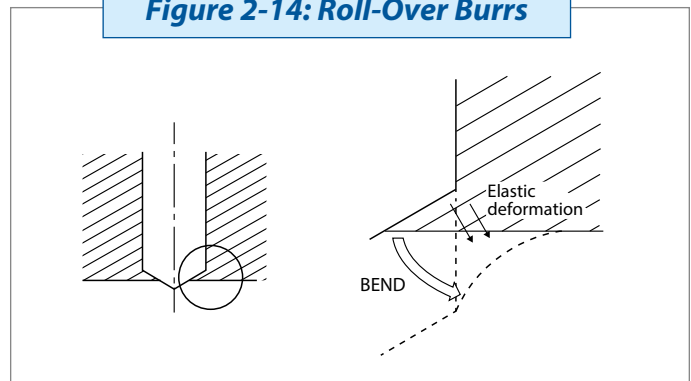

Drilling Technical Guide



Proper Application and Usage of Drilling Tools

How to avoid burrs:

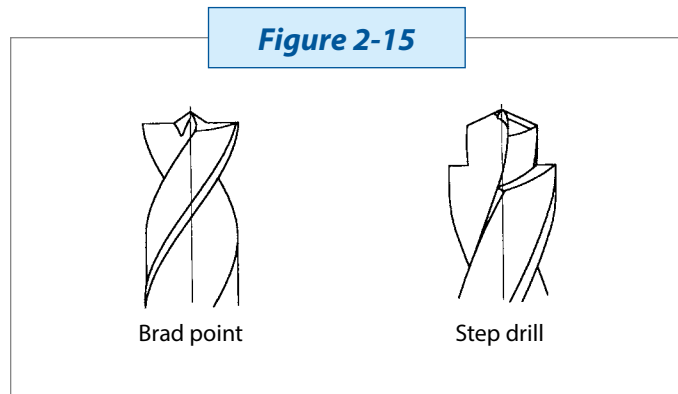
- (a) Select a drill with a high helix angle for sharper cutting.
- (b) Change the point angle to 60° in order to reduce thrust force.
- (c) Change to a Brad point or step drill.
- (d) Decrease the feed rate.
- (e) Add a radius on corner.

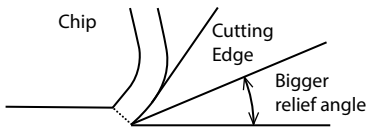
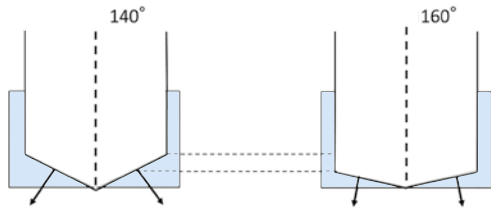

Counter measure for burring

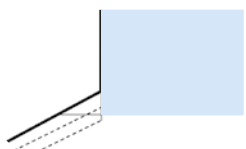
Bigger relief angle	Effect
	<p>Makes the cutting edge sharper and reduces cutting force.</p>
Larger point angle	Effect
	<p>Decreases the thickness of the rolled over material as the drill point exits the work material.</p>
Add a second angle or corner radius	Effect
	<p>Change thickness of chip and change the direction of cutting force.</p>
Reduce feed rate	Effect
	<p>The smaller depth of cut per revolution, the smaller cutting force.</p>

Comparison of burring with each point shape

The following shows the results of tests done for each point shape.

The step drill with 180° chamfer angle, and also the flat bottom drill, proved to have the smallest burring.

Figure 2-16

Cutting parameter

Diameter	Ø4
Work material	Alloy steel
Work Shape	Ø22.5xØ18 x 43mm
Coolant	Water-soluble coolant

Work Shape

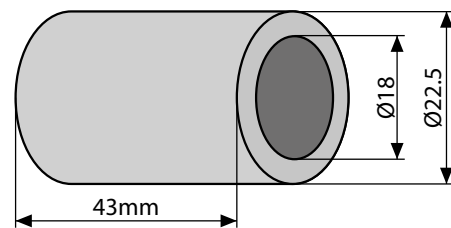

Tool Type	Drill Side Profile Shape	Exit Burr Condition
Chamfer angle 140° Diameter of 1st step Ø3.5		
Chamfer angle 180° Diameter of 1st step Ø3.5		
Corner chamfer C0.1		
Flat bottom (180°)		
Brad point		

Part 3: Cutting Parameter

3.1 Formula for Cutting Parameter

V_c : Cutting Speed (m/min)	$V_c = \frac{\pi \cdot D_c \cdot n}{1,000}$
V_f : Table Feed (mm/min)	$V_f = f \cdot n$
D_c : Tool diameter (mm)	
n : RPM (min^{-1})	
π : 3.14	$n = \frac{1,000 \cdot V_c}{\pi \cdot D_c}$
f : mm/rev	

V_c : Cutting Speed (SFM)	$V_c = \frac{\pi \cdot D_c \cdot n}{12}$
V_f : Table Feed (IPM)	$V_f = f \cdot n$
D_c : Tool diameter (inch)	
n : RPM (min^{-1})	
π : 3.14	$n = \frac{12 \cdot V_c}{\pi \cdot D_c}$
f : IPR (inch/rev)	

The machining efficiency of the drill is indicated by the table feed, V_f (mm/min or ft/min, alternatively "SFM"). Generally, the speed of a HSS drill is greatly affected by the spindle rotation speed, RPM. The effect of the feed rate per revolution in a HSS drill is small relative to changes in speed, so increasing the feed rate is an effective method for improving drilling efficiency. However, as feed rate increases, the thickness of the chip also increases. At some point, too thick a chip will adversely affect the drill's machining performance, so the optimal drilling feed rate should be determined by the chip shape.

In a carbide drill, the cutting edge has a chamfer with a negative rake angle, and thus the range of appropriate feed rate is smaller than that of HSS drill. Outside of this range, the life of the tool will be greatly reduced. Because carbide has much higher heat resistance than HSS tools, it is advantageous to increase the machining efficiency by increasing the cutting speed (RPM).

3.2 Coolant

The type of cutting fluid and the lubrication method have a great influence on drilling tool life and finished-surface accuracy.

The function and purpose of coolant is as follows:

(a) Lubrication:

Tool life extension, friction reduction, surface roughness and cutting condition improvement, cutting force reduction

(b) Cooling function:

Tool life extension, cutting temperature reduction, finishing accuracy improvement

(c) Cleaning action:

Chip removal, surface roughness, finishing accuracy improvement

Cutting fluids are classified into water-soluble and oil. Oil is excellent in lubricity and anti-adhesion. In addition, it also has an anti-corrosion characteristics, so it is effective in preventing corrosion in machines and work pieces. On the other hand, water-soluble coolants have a large cooling effect, do not emit smoke, and are not flammable, so they are often used for environmental reasons. However, the tool life may be significantly reduced if coolant-to-oil ratio is low. So it is necessary to regularly check the coolant concentration to avoid unstable tool performance from tool to tool. Regardless of which cutting fluid is used, it is important to consider the method in which coolant is supplied such as: flow rate, pressure, number of nozzles, and internal drilling, so that sufficient fluid reaches the cutting zones.

Recently, in response to environmental concerns, dry processing and semi-dry processing have been actively researched in order to reduce the amount of oil and energy used for coolant supply.

The application range of dry processing is extremely limited in terms of cooling and chip evacuation, but semi-dry drilling using air and oil mist has seen good potential.

Figure 3-1: Tool Life Comparison

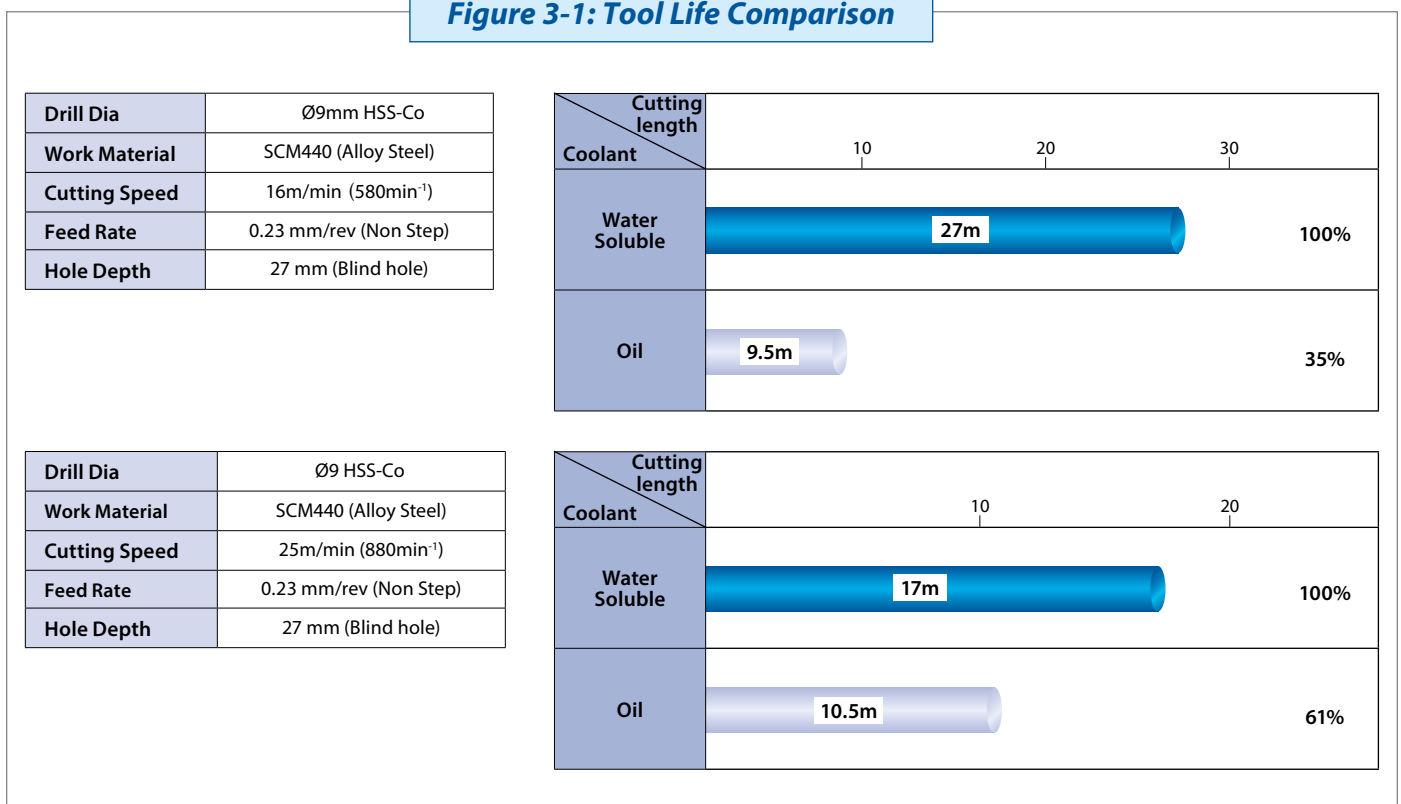

Part 4: Regrind

4.1 When to Regrind?

Regrind frequency is decided by the following:

(a) Wear amount (see below diagrams for common wear locations)

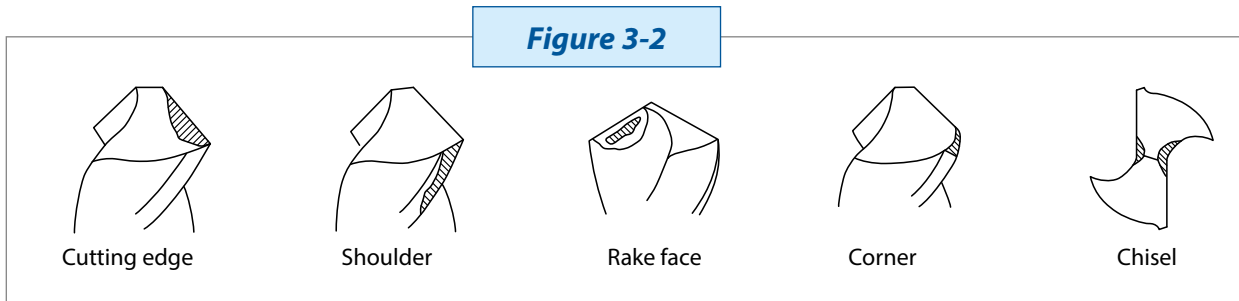

(b) Hole diameter size, accuracy, surface roughness

(c) Color of chips, shape of chips

(d) Cutting force (Sounds, Chattering)

(e) Number of holes/parts

It is necessary to decide on easy-to-manage and easy-to-spot regrind criteria as it relates to the bullet points mentioned above. Drill regrinding only re-finishes the drill point surfaces, and in the case of judging tool wear, if the drill has been used and exhibits an excessive amount of wear, it will take a longer time to regrind that tool, and its overall tool life will be shortened.

It is important to determine the economical tool wear amount by considering the total life of one drill.

$\text{New Tool Life} + [\text{Re-grind tool life} \times \# \text{ Re-grinds}] = \text{Drill Tool Life}$.

Guidelines for regrinding

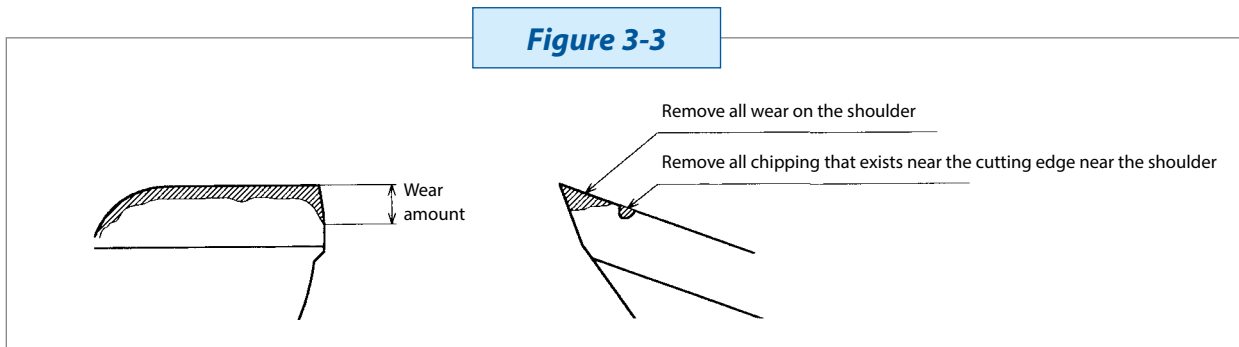

When trying to define criteria for the appropriate regrinding frequency, one can use the machined hole quality as a metric. If the required hole size grows out of tolerance (oversized), or when the hole loses its straightness, as measured by a limit gage, cylinder gage, etc., these are common signs for the need to regrind.

Another useful metric is to keep the torque, thrust, required power, etc. within a certain range.

Lastly, the number of holes per drill should be monitored and used as a metric to decide regrind timing. Determining the appropriate number of holes per drill should be a number reflecting the consideration of all the aforementioned metrics.

4.2. How to Regrind

In order to obtain the best results, drills should be reground as if they were brand new. However, some customers can't achieve this precision because they use different regrinding machines. The following recommendations will help users gain better results with reground drills:

- Maintain a low grinding temperature when sharpening HSS drills
- Completely remove all chipping and wear
- After regrinding, keep as small of a lip height difference and chisel edge runout as possible
- Use the same point angle as the original design
- When regrinding, try to avoid chipping, small breakages, and grinding burrs

Figure 3-4: Cutting Edge Rectification

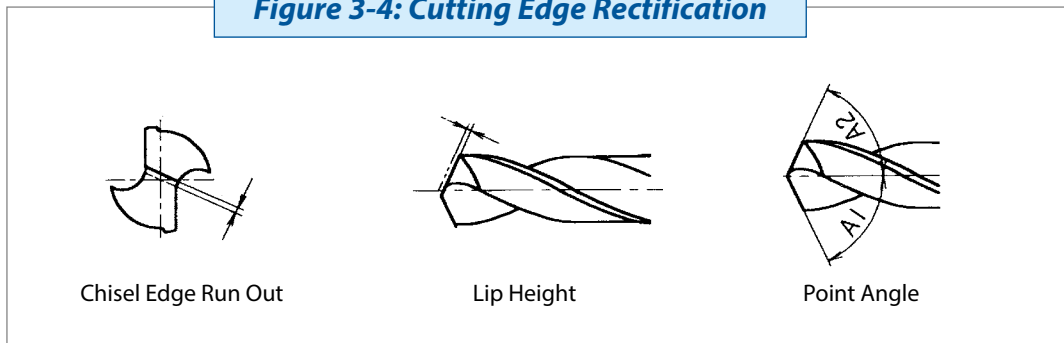

Part 5: Applications

Flat bottom Drill



Application		Feature
<p>Piloting on angled surface</p> <p>Interrupted drilling</p> <p>Curved surface</p>	<p>The flat drill is a drill with a tip angle of 180° (flat) and can serve multiple-functions. In addition, the bottom surface of the processed hole can be made completely flat and burring on the backsides of the holes can be suppressed.</p>	

Drilling Technical Guide

Proper Application and Usage of Drilling Tools

Leading (Spotting) Drill

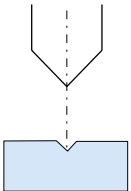
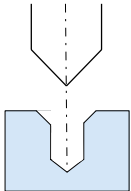

Application	Feature	
<div style="display: flex; justify-content: space-around;"> <div style="text-align: center;"> <p>Centering</p>  </div> <div style="text-align: center;"> <p>Chamfering</p>  </div> </div>	<p>Drill for centering before drilling, and for chamfering after drilling</p>	

Step Drill

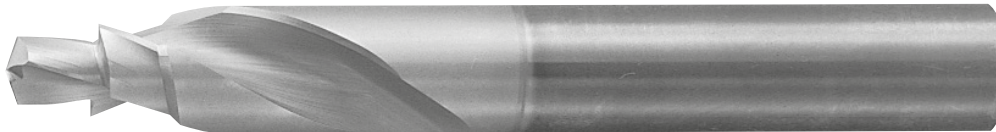

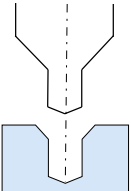
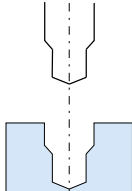
Application	Feature	
<div style="display: flex; justify-content: space-around;"> <div style="text-align: center;"> <p>Drilling + Chamfering</p>  </div> <div style="text-align: center;"> <p>Drilling + counterboring Drilling + countersinking</p>  </div> </div>	<p>Step drill is a drill that has two or more different diameters, and can be used for chamfering and counterboring within one drilling cycle.</p>	

Core Drill

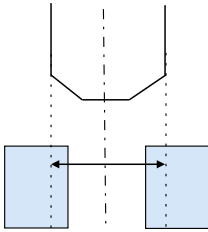

Application	Feature	
<p data-bbox="396 604 456 632">Boring</p> 	<p data-bbox="760 695 1179 825">Core drill is used for boring a pre-existing hole. Due to smaller chip removal amounts in this type of application, a bigger core diameter can be applied to the drill, providing better hole precision.</p>	

Part 6: Drilling Tips for Special Work Shape

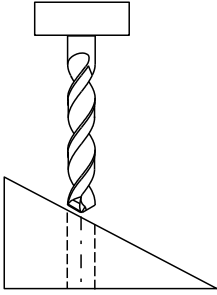
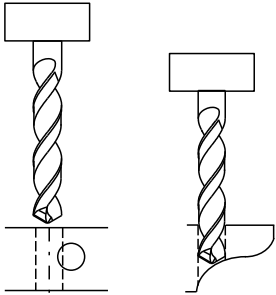
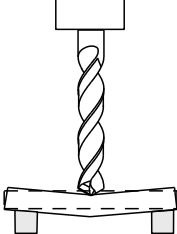
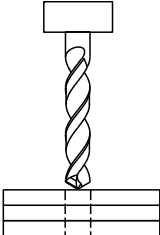
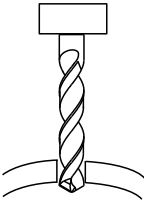

Angled or curved surface	Tips
	<ol style="list-style-type: none"> 1. Counterbore before drilling. 2. Centering/spotting before drilling. 3. Use bushing for extra guidance. 4. Use a high stiffness drill (higher core diameter, short overhang). 5. Reduce feed rate.
Cross-hole, uneven surface at exit	Tips
	<ul style="list-style-type: none"> • Use high stiffness drill (higher core diameter, short overhang). • Reduce feed rate. • Plug the cross hole with same material. • Use double margin drill. • Use larger point angle drill.
Thin plate	Tips
	<ol style="list-style-type: none"> 1. Use enough supports to avoid bending the plate. 2. Reduce feed rate. 3. Use brad point drill.
Stack material	Tips
	<ol style="list-style-type: none"> 1. Step drill. 2. Reduce feed rate. 3. Use brad point drill.
Cylindrical parts (Burr issue)	Tips
	<ol style="list-style-type: none"> 1. Use flat bottom drill. 2. Use brad point drill.

Part 7: Drilling Tips for Difficult to Machine Material

Work Material	Material Feature	Tips
Austenitic Stainless Steel SUS304, SUS316	<ul style="list-style-type: none"> • High work hardening. • High tensile strength at high at high temperature. • Low thermal conductivity. 	<ul style="list-style-type: none"> • Use tough drill material with sharp cutting edge and coating. • High coolant supply. • Too slow feed is not good for chip shape.
Die Steel D2, H13	<ul style="list-style-type: none"> • High hardness. • Tool wears quickly. 	<ul style="list-style-type: none"> • Use high oxidation temperature coating. • Use high hardness coating. • Use slower RPM, higher feed rate.
High Manganese Steel SCMnH	<ul style="list-style-type: none"> • High tensile strength and high toughness. • High work hardening. 	<ul style="list-style-type: none"> • Use rigid tool, machine, and work holding. • Use a low cutting speed and a low feed rate.
Titanium Ti-6Al-4V	<ul style="list-style-type: none"> • High tensile strength and high toughness. • Low thermal conductivity. • Low chemical stability. 	<ul style="list-style-type: none"> • Use coolant to maintain a low cutting temperature.
HRSA Inconel, Hastelloy	<ul style="list-style-type: none"> • Work hardening. • High hardness. • Low machinability. 	<ul style="list-style-type: none"> • Use a rigid tool and rigid machine. • Bigger shank to increase gripping force.
High Silicon Aluminum AC9A, A390	<ul style="list-style-type: none"> • Hard grains of silicon carbide is abrasive to the tooling and causes quicker wear. 	<ul style="list-style-type: none"> • High hardness substrate material. • High coolant supply for lubrication.
Kovar Fe-Ni-Co	<ul style="list-style-type: none"> • Low thermal conductivity. • Massive welding. 	<ul style="list-style-type: none"> • Sharpness on cutting edge is important. (High helix, small hone)
Composite Material CFRP GFRP	<ul style="list-style-type: none"> • Huge abrasive wear due to hard fibers. • Delamination. 	<ul style="list-style-type: none"> • Need both sharpness and wear resistance. • Diamond coating.

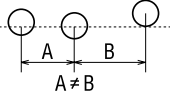
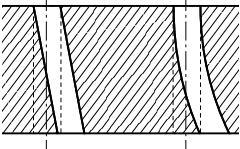
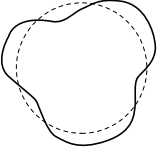
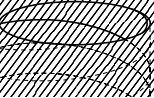
Part 8: Troubleshooting

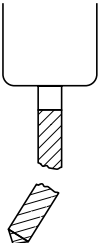
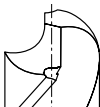
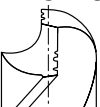
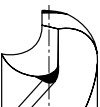
	Type of Trouble	Reasons for the trouble	Solution
Hole	Hole Expansion	Run out of drill when attached to the machine. Loose hold.	Check holder and/or select another one. Check run out after fixing to the chuck.
		Non-symmetric point angle. Large lip height. Run out of chisel edge.	Regrind correctly. Check precision after regrind.
	Irregular Hole Size	Non-symmetric point angle. Large lip height. Run out of chisel edge. Margin wear is large.	Regrind correctly. Check precision after regrind.
		Large run out after attached to the machine. Loose hold. Low work holding rigidity.	Check holder & select another one. Check run out after fixing the chucking.
		Feed rate too high. Not enough lubrication.	Decrease feed rate. Use drill with through-tool coolant holes.
	Low Position Accuracy 	Large run out when attached to the machine. Large spindle run out.	Check holder and/or select another one. Check run out after fixing the chucking.
		Run out when cutting material.	Select more rigid tool and machine. Increase work clamping rigidity. Select a low cutting resistance thinning. Use centering. Work piece should be horizontal. Use a drill bushing.
		Low alignment accuracy (for lathing)	Check alignment.
	Hole Perpendicularity 	Excessive tool wear.	Regrind.
		Low position accuracy.	Use a thinned drill point. Use a centering drill.
		Non-symmetric point angle. Large lip height. Run out of chisel edge	Regrind correctly. Check precision after regrinding.
		Not enough drill rigidity.	Increase drill rigidity
		Drilling surface is not horizontal. Poor alignment (for lathing)	Work piece must be horizontal. Make a center hole. Check alignment.
	Bad Cylindrical Accuracy 	Non-symmetric point angle. Large lip height. Run out of chisel edge	Regrind correctly. Check precision after regrinding.
		Large run out after attached to machine. Loose hold. Low work holding rigidity.	Check holder and/or select another one. Check run out after fixing the chucking.
		Relief angle is too large.	Regrind correctly.
		Low drill rigidity.	Use carbide drill or large web drills.
	Poor Surface Finish	Poor regrinding.	Take off all the wear.
		Not suitable coolant for the material. Not enough coolant.	Change supply method; increase volume. Select higher coolant quality.
		Large run out after attached to machine. Loose hold.	Check holder and/or select another one. Check run out after fixing to the chuck.
		Feed rate is too high.	Reduce feed rate.
		Excessive tool wear. Build up on margin is too large.	Regrind correctly. Select a coated tool.
Bad Cylindrical Shape 	Chip packing.	Select suitable drill (wide flute, high helix, oil hole drill). Change cutting conditions (feed rate or adopt step drilling).	
	Non-symmetric point angle. Large lip height. Run out of chisel edge. Large margin wear.	Regrind correctly. Check precision after regrinding.	
	Feed rate is too low.	Increase feed rate.	

Type of Trouble	Reasons for the trouble	Solution
Drill Breakage 	Inaccurate machine Work material deformation.	Increase the rigidity of machine, drill and work clamping.
	Relief angle is too small.	Regrind correctly.
	Feed rate is too high.	Decrease the feed rate.
	Excessive tool wear.	Regrind correctly.
	Chip packing.	Select suitable drill (wide flute, high helix, oil hole drill). Change cutting conditions (feed rate or adopt step drilling).
	Difficulty entering the material.	Select high rigid tool & rigid machine. Increase work clamping rigidity. Select a low cutting resistance thinning. Use centering. Work piece should be horizontal. Use bushing with drill.
Chipping of Corner Edge 	Inappropriate tool material.	Choose suitable tool material.
	Uneven hardness distribution on the work material.	Iso static treatment. Change tool, material & cutting conditions, machining method (EDM).
	Cutting or feed speed is too high.	Reduce cutting speed or feed
	Not enough coolant.	Change lubrication method.
Chipping of Cutting Edge 	Large run out after attached to machine. Loose hold.	Check holder and/or select another one. Check run out after fixing to the chuck.
	Relief angle is not suitable.	Regrind correctly.
	Tool material is not suitable.	Choose suitable tool material.
	Cutting speed or feed is too high.	Reduce cutting speed or feed.
Abnormal Wear on Corner Part 	Tool late regrinding.	Regrind after a shorter time of use.
	Bad alignment (for lathe turning).	Check / adjust the alignment.
	Cutting speed too high.	Decrease the cutting speed.
	Point dimension are not suitable.	Select correct point dimensions.
	Tool materials not suitable.	Choose suitable tool material.
	Coolant is not suitable.	Change coolant.
Large Wear and Chipping, Crushing of the Chisel Edge	Feed rate is too large.	Decrease feed rate.
	Point dimension are not suitable.	Select correct point dimensions.
	Tool material is not suitable.	Choose suitable tool material.
	Relief angle is too small.	Increase relief angle.
Chipping of Margin	Bush diameter is too small. Chip packing between drill & bush.	Select correct bush diameter or select drill with chip breakers.
	High heat generation due to large wear on the cutting edge.	Regrind.
Margin Build-up	Lubrication is insufficient.	Change lubrication method.
	Coolant is not suitable.	Change coolant.
	Bad chip ejection. Ductile material.	Change drill or the cutting conditions.
Tang Breakage 	Shank slippage due to some kind of defect.	Take off the defect by honing the surface.
	Defect of the inner surface of morse taper holder.	Change holder or correct the surface of morse taper holder.
	Low accuracy of regrinding.	Regrind correctly.
Noise of Chattering	Relief angle is too big.	Grind a smaller relief angle.
	Low rigidity of the tool.	Use drill with high rigidity.
Chip Rolled Around the Drill	Low extended and curly chips. Chips are stuck in the flute.	Change drill and cutting conditions.
One side Wear	Large run out after attached to machine.	Check holder and/or select another one. Check run out after fixing to the chuck.
	Bad alignment (for lathe turning).	Check / adjust the alignment.

Drill

